

We build a better future

**Robex**  
**55W-9**

Equipped with Tier IIIa Engine



\*Photo may include optional equipment.

# Pleasure works

An operator, who takes pleasure in his work, does a better job. That is why we at Hyundai Heavy Industries do everything we can to make that happen. We merged operator preference, fast precision and lasting performance into a quality product. Hyundai 9 Series earthmoving equipment simply makes time fly, makes pleasure work!



\*Photo may include optional equipment.

---

## Machine Walk-Around

---

### **Robust Upper and Lower Frame**

The structure of the upper frame is designed to absorb high stress and to resist inherent external influences. Reinforced undercarriage and fenders provide exceptional strength and longer service life to withstand tough working conditions.

### **Engine Technology**

Powerful and reliable, Tier 3a certified, fuel efficient Yanmar 4TNV98 engine.  
Electronically controlled, clean and efficient combustion.  
Low noise / anti-restart function.

### **Control System**

Control devices are well located for increased operator's comfort and a higher productivity. The operator can easily control the machine in any working condition. A safety lever on the left side console is installed to prevent exiting the cabin with active hydraulic control levers.

### **Advanced Hydraulic System**

Our new R55W-9 is equipped with arm flow summation system, boom holding system and swing parking brake for smooth and fine control. Other integrated features are hydraulic damper in travel pedals, swing reducer lubrication by hydraulic oil and leak-free grease chamber of swing bearing.

### **Comfortable and High-Strength Cabin**

The spacious cabin is ergonomically designed, with low noise level and high visibility. Canopy & cabin frame are complying with international standard TOPS, ROPS & FOPS, for maximum protection of the operator.

### **Operators' Convenience**

R55W-9 cabin equipped with suspension seat and various storage space for advanced operator comfort. The newly designed LED-cluster displays engine RPM, engine temperature, fuel level and state of electric devices to check the full status of the machine at a single glance. Diagnostic functions are also integrated. Powerful air conditioning and radio with MP3-player make a Hyundai excavator a pleasure to operate.

### **Easy to Maintain**

With open access of doors, covers and engine hoods, air cleaner and centralized grease fittings the machine is a pleasure to maintain.

### **Extended Life of Components**

Long-life hydraulic filters, long-life hydraulic oil, long-lasting shims and long-lasting bushes are reducing operation costs.

# Preference

An operator, who sets his machine to his needs, takes pleasure in his work. Our R55W-9 respects operator preference with regards to comfort, ease-of-use and controllability. Operators can fully customize their work environment and operating preferences to fit their individual needs.



\*Photo may include optional equipment.



## Spacious Cabin with Excellent Visibility

The spacious cabin is ergonomically designed with low noise levels and high visibility. Special attention was paid to create a clear, open and convenient interior with excellent visibility in all directions. This well balanced operators' environment put the operator in the perfect position to work safely and securely.

## Operator Comfort

In the cabin of our R55W-9 you can experience the highest level of comfort. The ergonomic location of joysticks with arm rests, suspension seat, control levers and LED-display minimizes fatigue of the operator. The LED-display shows all information of the machine with a blink of an eye.

1. A large top glass combined with a roll-up sun visor offers high visibility.
2. An advanced audio system with radio / MP3-player with AUX-input, combined with a remote control is installed to listen to your preferred music favorites.
3. Operators are able to call while operating with the hands-free mobile phone feature.
4. Ergonomically designed joysticks reduce operator fatigue.
5. Cabin provides various storage compartments for operator's convenience.



Roll-up Sun visor    Radio / MP3-player with remote control    Hands-free cell phone    Ergonomic joysticks    Storage compartments

## Stressless

Work is stressful enough; your working environment should be stressless. Hyundai's R55W-9 compact excavator provides many convenient devices for safe and productive work.

1. The window locking device keeps the right window in the preferred position.
2. The sliding front window is easy to open and can be locked safely in open position to improve ventilation and visibility.
3. The tiltable left-side console box offers easy access to the cabin.
4. The powerful temperature control provides the operator with the preferred air temperature.



Window locking device

Sliding front window

Tilttable console box

Climate control system



## Easy-to-use Cluster

The advanced LED-cluster allows the operator to select his personal machine preferences. The monitor displays engine rpm, engine temperature and state of electronic devices. The operator can select auto deceleration mode and max power mode and he can control travel speed with the touch of a button. An engine starting lock prevents theft of the machine.

# Precision & Performance

An operator, who feels his machine respond smoothly, takes pleasure in his work. 9 Series deliver fast precision by combining smoother hydraulics with wider view and less stress. Innovative hydraulic system technologies make the R55W-9 excavator fast, smooth and easy to control.



\*Photo may include optional equipment.

## Excellent Performance

Hyundai's 9 series offer maximum productivity and high efficiency. With the engine dial, the operator can adjust the engine power to the specific application. A max power button maximizes machine speed and power for maximum productivity. R55W-9 features auto deceleration to reduce fuel consumption and cabin noise level.

## Improved Hydraulic System



To achieve optimum precision, Hyundai redesigned the hydraulic system to provide the operator with super fine touch and high controllability. Improved pump flow control reduces hydraulic flow when controls are not activated to minimize fuel consumption. Improved spool valves in the main control valve are engineered to provide more precise flow to each function with less effort. Improved hydraulic valves, precise variable volume piston pumps, fine-touch pilot controls and enhanced travel functions make any operator of our 9 series look like a smooth operator. Additional features include arm and boom regeneration, combined with automatic boom vs. swing priority for optimal performance in any application.

## Offset Boom

The R55W-9's boom offset function is designed for efficient work in congested residential and urban areas. The boom can be offset from 80° to the left up to 50° to the right. Increased swing torque provides better operating capability on a slope.

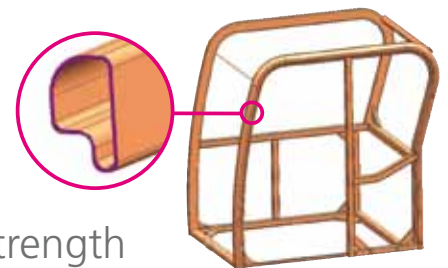
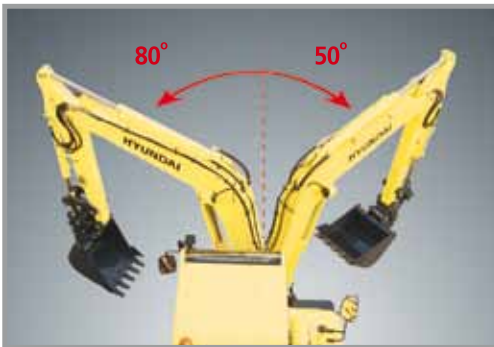

## Structural Strength

The 9 Series cabin structure is designed with slimmer but stronger tubing for more safety and better visibility. Low-stress and high strength steel is welded to form a strong and stable lower frame. Structural durability is analyzed and tested by FEM-analysis (Finite Elements Method) and long-term durability tests.



## Yanmar 4TNV98

Yanmar 4TNV98 engine provides a nominal power of 57 HP at 2.400 rpm. This means the R55W-9 runs with the most power in its class, giving you more power to get the job done. This engine meets TIER 4 Interim / EU stage IIIa emission regulations.

# Profitable

An owner, who knows his machine saves money, takes pleasure in owning it. 9 Series excavators contribute to your business as a time, fuel, spare-part and cost saving earthmoving solution.



\*Photo may include optional equipment.



## Fuel Efficient

9 series compact excavators are engineered to be very fuel efficient. A cooling fan with viscous fan clutch will reduce fuel consumption and will reduce the noise level in the cabin.

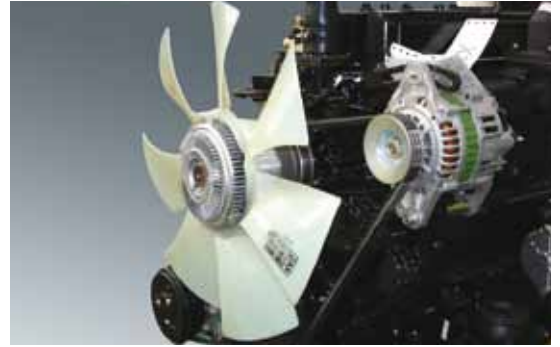

## Improved Durability

The R55W-9 is equipped with side protection of the counterweight to protect the engine hood. A cover of the dozer cylinder provides extra protection in tough working conditions.



## Easy Maintenance

Centralized grease fittings and easy to change air filter provide faster and easier maintenance.

## Large Engine hood

9 series compact excavator are offering easy access to the engine compartment with a large engine hood.



## Extended Life of Components

By adopting long-life hydraulic filters (1000 hrs) and long-life hydraulic oil (5000 hrs) operation costs are reduced. Extended lubricant bush life & ultra high molecular weight polymer shim, more efficient cooling systems and integrated preheating systems are extending service intervals and reducing machine down time.

# Specifications

## ENGINE

MODEL	YANMAR 4TNV98		
Type	Water cooled, 4 cycle Diesel, 4-Cylinders in line, direct injection and low emission		
Rated flywheel horse power	SAE	J1995 (gross)	57 HP (42.5 kW) at 2,400 rpm
		J1349 (net)	55.2 HP (41.2 kW) at 2,400 rpm
	DIN	6271/1 (gross)	57.8 PS (42.5 kW) at 2,400 rpm
		6271/1 (net)	56 PS (41.2 kW) at 2,400 rpm
Max. torque	20.5 kgf.m (148 lbf.ft) at 1,550 rpm		
Bore x stroke	98 mm (3.86") x 110 mm (4.33")		
Piston displacement	3,319 cc (203 cu in)		
Batteries	1 x 12 V x 100 AH		
Starting motor	12 V - 3.0 kW		
Alternator	12 V - 80 Amp		

## HYDRAULIC SYSTEM

MAIN PUMP	
Type	Two variable displacement piston pumps
Max. flow	2 x 55 ℓ/min (14.5 US gpm / 12.1 UK gpm)
Sub-pump for pilot circuit	Gear pump
Cross-sensing and fuel saving pump system	

HYDRAULIC MOTORS	
Travel	Two speed axial piston motor with brake valve and parking brake
Swing	Axial piston motor with automatic brake

RELIEF VALVE SETTING	
Implement circuits	220 kgf/cm <sup>2</sup> (3,130 psi)
Travel	220 kgf/cm <sup>2</sup> (3,130 psi)
Swing circuit	220 kgf/cm <sup>2</sup> (3,130 psi)
Pilot circuit	30 kgf/cm <sup>2</sup> (430 psi)
Service valve	Installed

HYDRAULIC CYLINDERS	
No. of cylinder-bore x rod x stroke	Boom: 1 - 110 x 60 x 715 mm (4.3"x 2.4"x 28.1")
	Arm: 1 - 90 x 55 x 850 mm (3.5"x 2.2"x 33.5")
	Bucket: 1 - 80 x 50 x 660 mm (3.1"x 2.0"x 26.0")
	Boom swing: 1 - 95 x 50 x 527 mm (3.7"x 2.0"x 20.7")
	Dozer blade: 1 - 100 x 50 x 189 mm (4.3"x 2.0"x 7.5")

## DRIVES & BRAKES

Max. travel speed	27 km/hr (16.8 mph)
Gradeability	35° (70%)

## CONTROL

Pilot pressure operated joysticks and pedals with detachable lever provide almost effortless and fatigueless operation.

Pilot control	Two joysticks with one safety lever (LH): Arm and swing (RH): Boom and bucket (ISO)
Traveling and steering	Pedal and steering wheel
Engine throttle	Electric, Dial type
Lights	Two lights mounted on the boom, one light mounted under the battery box one light mounted under the cabin

## SWING SYSTEM

Swing motor	Axial piston motor
Swing reduction	Planetary gear reduction
Swing bearing lubrication	Grease-bathed
Swing brake	Multi wet disc
Swing speed	9.3 rpm

## COOLANT & LUBRICANT CAPACITY

Refilling	liter	US gal	UK gal
Fuel tank	125.0	33.0	27.5
Engine coolant	9.5	2.5	2.1
Engine oil	11.6	3.1	2.6
Swing device - gear oil	1.5	0.4	0.3
Hydraulic tank	70.0	18.5	15.4
	120.0	31.7	26.4
Axle (Front / Rear)	5.3 / 5.3	1.4 / 1.4	1.2 / 1.2

## AXLE & WHEELS

Full floating front axle is supported by center pin for oscillation. It can be locked by oscillation lock cylinders. Rear axle is fixed on the lower chassis.

Tires	12.0 x 16.5-12PR, single
-------	--------------------------

## DOZER BLADE

Pin-on type dozer blade is standard. Dozer blade is a very useful addition for leveling, back filling or clean-up work.

Dozer blade	Width x Height 1,925 x 355 mm (6' 4" x 1' 2" )
	Max. lifting above ground level 445 mm (17.5")
	Max. depth below ground level 140 mm (5.5")

## OPERATING WEIGHT (APPROXIMATE)

Operating weight, including 3,000 mm (9' 10") boom; 1,600 mm (5' 3") arm, SAE heaped 0.18 m<sup>3</sup> (0.24 yd<sup>3</sup>) bucket, lubricant, coolant, full fuel tank, full hydraulic tank, and all standard equipments.

MAJOR COMPONENT WEIGHT	
Upperstructure	2,680 kg (5,910 lb)
Counterweight	210 kg (460 lb)
Mono boom (with arm cylinder)	310 kg (680 lb)

OPERATING WEIGHT	
Operating weight	5,550 kg (12,240 lb)

- Mono boom with blade

## BUCKETS

Capacity		Width		Weight
SAE heaped	CECE heaped	Without side cutters	With side cutters	
0.07 m <sup>3</sup> (0.09 yd <sup>3</sup> )	0.06 m <sup>3</sup> (0.08 yd <sup>3</sup> )	315 mm (12.4")	360 mm (14.2")	115 kg (255 lb)
0.18 m <sup>3</sup> (0.24 yd <sup>3</sup> )	0.15 m <sup>3</sup> (0.20 yd <sup>3</sup> )	670 mm (26.4")	740 mm (29.1")	170 kg (375 lb)

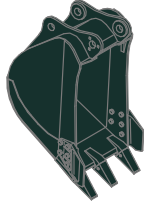

SAE heaped m<sup>3</sup> (yd<sup>3</sup>)

0.07 m<sup>3</sup> (0.09 yd<sup>3</sup>)

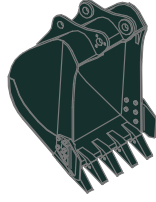

0.18 m<sup>3</sup> (0.24 yd<sup>3</sup>)

## DIGGING FORCE

Arm	Length	1,600 mm (5' 3")	1,900 mm (6' 3")
	Weight	210 kg (460 lb)	230 kg (510 lb)
Bucket digging force	SAE	37.7 kN	37.7 kN
		3,850 kgf	3,850 kgf
		8,490 lbf	8,490 lbf
	ISO	42.4 kN	42.4 kN
		4,330 kgf	4,330 kgf
		9,550 lbf	9,550 lbf
Arm crowd force	SAE	28.4 kN	25.5 kN
		2,900 kgf	2,600 kgf
		6,390 lbf	5,730 lbf
	ISO	31.9 kN	28.7 kN
		3,260 kgf	2,930 kgf
		7,190 lbf	6,460 lbf

\* Arm weight includes bucket cylinder and bucket linkage.

## Lifting Capacities

### R55W-9



Rating over-front



Rating over-side or 360 degrees

Boom : 3.0 m (9' 10") / Arm : 1.6 m (5' 3") / Bucket : 0.18 m<sup>3</sup> (0.24 yd<sup>3</sup>) SAE heaped / Dozer blade down with 210 kg (460 lb) counterweight.

Load point height m (ft)		Load radius								At max. reach		
		2.0 m (7 ft)		3.0 m (10 ft)		4.0 m (13 ft)		5.0 m (16 ft)		Capacity		Reach m (ft)
5.0 m (16 ft)	kg lb									*960	*960	4.47 (14.7)
4.0 m (13 ft)	kg lb					*1020	*1020			*990	720	5.26 (17.3)
3.0 m (10 ft)	kg lb					*1150	1120	*990	760	*1020	620	5.69 (18.7)
2.0 m (7 ft)	kg lb			*1900	1690	*1400	1070	*1200	740	*1070	570	5.86 (19.2)
1.0 m (3 ft)	kg lb			*2500	1580	*1670	1020	*1310	720	*1110	570	5.81 (19.1)
Ground Line	kg lb	*2690	*2690	*2720	1530	*1820	990	*1350	700	*1160	620	5.51 (18.1)
-1.0 m (-3 ft)	kg lb	*4040	3040	*2610	1520	*1760	980	*2980	1540	*2560	1370	4.92 (16.1)
-2.0 m (-7 ft)	kg lb	*3400	3100	*2090	1550							
		*7500	6830	*4610	3420							











- Lifting capacity is based on SAE J1097, ISO 10567.
- Lifting capacity of the Robex Series does not exceed 75% of the tipping load with the machine on firm, level ground or 87% of full hydraulic capacity.
- The load point is a hook located on the back of the bucket.
- (\*) indicates the load limited by hydraulic capacity.

# Lifting Capacities











## R55W-9

 Rating over-front  Rating over-side or 360 degrees











Boom : 3.0 m (9' 10") / Arm : 1.6 m (5' 3") / Bucket : 0.18 m<sup>3</sup> (0.24 yd<sup>3</sup>) SAE heaped / Dozer blade up with 210 kg (460 lb) counterweight.

Load point height m (ft)		Load radius								At max. reach		
		2.0 m (7 ft)		3.0 m (10 ft)		4.0 m (13 ft)		5.0 m (16 ft)		Capacity		Reach m (ft)
												
5.0 m (16 ft)	kg									*960	880	4.47
	lb									*2120	1940	(14.7)
4.0 m (13 ft)	kg					*1020	*1020			760	650	5.26
	lb					*2250	*2250			1680	1430	(17.3)
3.0 m (10 ft)	kg					*1150	1010	810	690	650	550	5.69
	lb					*2540	2230	1790	1520	1430	1210	(18.7)
2.0 m (7 ft)	kg			1770	1510	1130	960	790	670	610	510	5.86
	lb			3900	3330	2490	2120	1740	1480	1340	1120	(19.2)
1.0 m (3 ft)	kg			1660	1410	1080	910	760	640	610	510	5.81
	lb			3660	3110	2380	2010	1680	1410	1340	1120	(19.1)
Ground Line	kg	*2690	2630	1610	1360	1040	880	750	630	650	550	5.51
	lb	*5930	5800	3550	3000	2290	1940	1650	1390	1430	1210	(18.1)
-1.0 m (-3 ft)	kg	3210	2650	1600	1350	1040	870			790	660	4.92
	lb	7080	5840	3530	2980	2290	1920			1740	1460	(16.1)
-2.0 m (-7 ft)	kg	3270	2700	1630	1380							
	lb	7210	5950	3590	3040							

Boom : 3.0 m (9' 10") / Arm : 1.9 m (6' 3") / Bucket : 0.18 m<sup>3</sup> (0.24 yd<sup>3</sup>) SAE heaped / Dozer blade down with 210 kg (460 lb) counterweight.

Load point height m (ft)		Load radius								At max. reach		
		2.0 m (7 ft)		3.0 m (10 ft)		4.0 m (13 ft)		5.0 m (16 ft)		Capacity		Reach m (ft)
												
5.0 m (16 ft)	kg					*940	*940			*880	840	4.88
	lb					*2070	*2070			*1940	1850	(16.0)
4.0 m (13 ft)	kg									*910	650	5.60
	lb									*2010	1430	(18.4)
3.0 m (10 ft)	kg					*1010	*1010	*1010	770	*940	560	6.00
	lb					*2230	*2230	*2230	1700	*2070	1230	(19.7)
2.0 m (7 ft)	kg	*3000	*3000	*1660	*1660	*1280	1080	*1120	750	*980	520	6.16
	lb	*6610	*6610	*3660	*3660	*2820	2380	*2470	1650	*2160	1150	(20.2)
1.0 m (3 ft)	kg	*1940	*1940	*2330	1590	*1580	1020	*1250	720	*1030	520	6.10
	lb	*4280	*4280	*5140	3510	*3480	2250	*2760	1590	*2270	1150	(20.0)
Ground Line	kg	*2520	*2520	*2670	1520	*1770	980	*1330	700	*1070	560	5.83
	lb	*5560	*5560	*5890	3350	*3900	2160	*2930	1540	*2360	1230	(19.1)
-1.0 m (-3 ft)	kg	*3580	3000	*2660	1500	*1790	970			*1110	650	5.29
	lb	*7890	6610	*5860	3310	*3950	2140			*2450	1430	(17.4)
-2.0 m (-7 ft)	kg	*3830	3050	*2290	1520	*1490	980			*1080	910	4.33
	lb	*8440	6720	*5050	3350	*3280	2160			*2380	2010	(14.2)
-3.0 m (-10 ft)	kg	*2070	*2070									
	lb	*4560	*4560									

Boom : 3.0 m (9' 10") / Arm : 1.9 m (6' 3") / Bucket : 0.18 m<sup>3</sup> (0.24 yd<sup>3</sup>) SAE heaped / Dozer blade up with 210 kg (460 lb) counterweight.

Load point height m (ft)		Load radius								At max. reach		
		2.0 m (7 ft)		3.0 m (10 ft)		4.0 m (13 ft)		5.0 m (16 ft)		Capacity		Reach m (ft)
												
5.0 m (16 ft)	kg					*940	*940			*880	760	4.88
	lb					*2070	*2070			*1940	1680	(16.0)
4.0 m (13 ft)	kg									690	580	5.60
	lb									1520	1280	(18.4)
3.0 m (10 ft)	kg					*1010	*1010	810	690	600	500	6.00
	lb					*2230	*2230	1790	1520	1320	1100	(19.7)
2.0 m (7 ft)	kg	*3000	2990	*1660	1540	1140	970	790	670	560	470	6.16
	lb	*6610	6590	*3660	3400	2510	2140	1740	1480	1230	1040	(20.2)
1.0 m (3 ft)	kg	*1940	*1940	1670	1420	1080	920	760	640	560	460	6.10
	lb	*4280	*4280	3680	3130	2380	2030	1680	1410	1230	1010	(20.0)
Ground Line	kg	*2520	*2520	1600	1350	1040	880	740	620	590	500	5.83
	lb	*5560	*5560	3530	2980	2290	1940	1630	1370	1300	1100	(19.1)
-1.0 m (-3 ft)	kg	3160	2610	1580	1330	1020	860			690	580	5.29
	lb	6970	5750	3480	2930	2250	1900			1520	1280	(17.4)
-2.0 m (-7 ft)	kg	3210	2650	1600	1350	1040	870			960	810	4.33
	lb	7080	5840	3530	2980	2290	1920			2120	1790	(14.2)
-3.0 m (-10 ft)	kg	*2070	*2070									
	lb	*4560	*4560									

- Lifting capacity is based on SAE J1097, ISO 10567.
- Lifting capacity of the Robex Series does not exceed 75% of the tipping load with the machine on firm, level ground or 87% of full hydraulic capacity.
- The load point is a hook located on the back of the bucket.
- (\*) indicates the load limited by hydraulic capacity.

# Dimensions & Working Ranges

## DIMENSIONS R55W-9

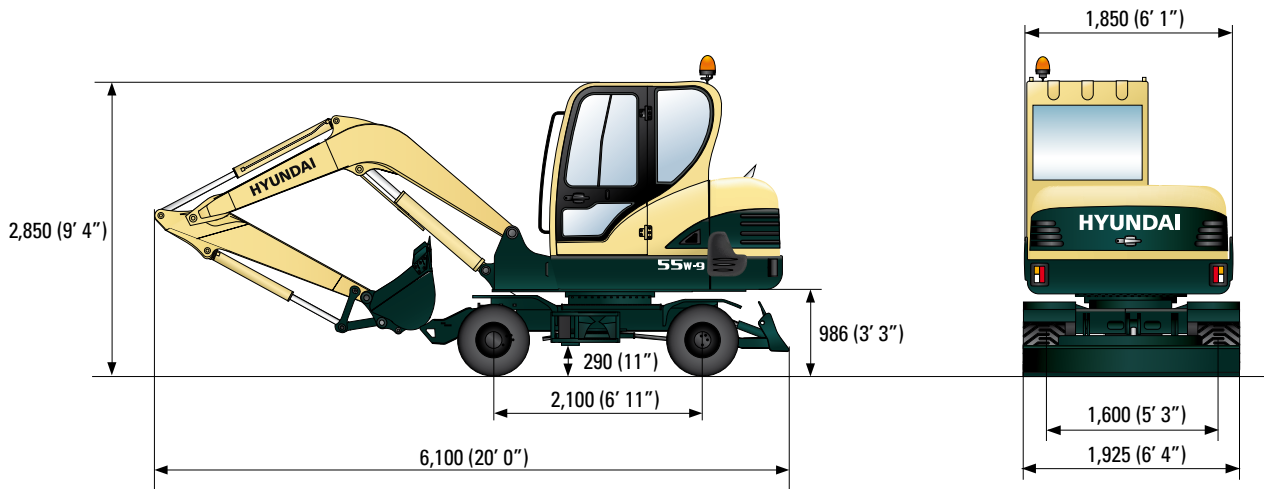

## WORKING RANGES R55W-9

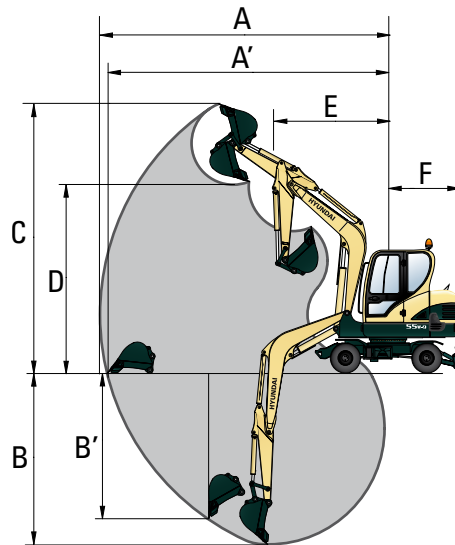

Boom length	3,000 (9' 10")	
Arm length	1,600 (5' 3")	1,900 (6' 3")
A Max. digging reach	6,150 (20' 2")	6,430 (21' 1")
A' Max. digging reach on ground	5,980 (19' 7")	6,200 (20' 4")
B Max. digging depth	3,500 (11' 6")	3,800 (12' 6")
B' Max. vertical wall digging depth	2,960 (9' 9")	3,160 (10' 4")
C Max. digging height	6,070 (19' 11")	6,260 (20' 6")
D Max. dumping height	4,340 (14' 3")	4,530 (14' 10")
E Min. swing radius	2,350 (7' 9")	2,350 (7' 9")
F Tail swing radius	1,650 (5' 5")	1,650 (5' 5")





## STANDARD EQUIPMENT

---

### ISO standard cabin

- Cabin ROPS (ISO 3471)  
FOPS (ISO 3449)  
TOPS (ISO 12117)
- All-weather steel cab with all-around visibility
- Safety glass windows
- Rise-up type windshield wiper
- Sliding fold-in front window
- Sliding side window
- Lockable door
- Accessory box & Ash-tray

### Centralized monitoring

- Engine speed
- Gauges
  - Fuel level gauge

- Engine coolant temperature gauge
- Warning
  - Fuel level
  - Engine oil pressure
  - Engine coolant temperature
  - Hyd. oil temperature
  - Low battery
  - Air filter clogging
- Fuel prefilter

Door and cab locks, one key fits all

Radio with MP3-player, with remote control

Two outside rear view mirrors

Fully adjustable suspension seat with seat belt

Console box tilting system (LH.)

Four front working lights

Electric horn

Battery (1 x 12 V x 100 AH)

Battery master switch

12 volt power supply

Removable clean out screen for radiator

Automatic swing brake

Removable reservoir tank

Water separator, fuel line

Counterweight

Mono boom (3.0 m; 9'10")

Arm (1.6 m; 5' 3")

Tires (12.0 x 16.5 - 12PR)

Blade (1925 x 354 mm; 6' 4" x 1' 2")

Starting aid (Air grid heater) Cold weather

Viscous fan clutch

## OPTIONAL EQUIPMENT

---

Air-conditioner & heater

Fuel filler pump (35 l/min, 9.2 US gpm)

Beacon lamp

Single acting piping kit (breaker, etc)

Double acting piping kit (clamshell, etc)

Accumulator, work equipment lowering

Quick coupler

Long arm (1.9 m, 6' 3")

Narrow bucket (0.07 m<sup>3</sup>, 0.09 yd<sup>3</sup>)

Tool kit

Operator suit

Mechanical suspension with heater

Additional working lamps

Standard and optional equipment may vary. Contact your Hyundai dealer for more information. The machine may vary according to international standards. All imperial measurements rounded off to the nearest pound or inch.

PLEASE CONTACT

